

Gazelle Script Form

Tennis Sports Wheelchair

90825



To Order Fill in the frame dimensions and features required. For variations describe in detail on a separate page. If you have any further questions contact us at the address at the bottom of the page.

SEND FORM

If online, click here to send via e-mail

Date	Delivery details				
Name					
Address					
Phone					
Fax / Cell	Required by				
Email	(Delivery is normally 4-6 weeks from order confirmation)				
Disability	Grading	Weight	Height	Shoe Size	T-Shirt Size

MEASUREMENTS (Refer to diagrams)

FRAME MATERIALS Aluminium (std) Titanium **90825T**

- | | | | |
|-----------------------------|---|---|---|
| A Seat Width - Rear | F Wheelbase
<small>(centre of camber bar to centre of castor pivot)</small> | M Anti-Tip Position | R <input type="checkbox"/> Binding Mounts
<small>(seat rail mounted)</small> AD20315 (A)
AD20318 (T) |
| A Seat Width - Front | G Seat to Floor - Front | N Camber | S <input type="checkbox"/> Ergo Seat AD10220 (A)
AD10221 (T) |
| A Back Width | H Seat to Floor - Rear | O Foot-plate Width | T Ergo Seat - Length |
| B Seat Length | I Balance Point | IMPORTANT Foot-plate Width
When measuring across feet you must add 2" (50mm) | U Ergo Back - Height |
| C Back Height | J Pivot Centres | | V Ergo Back - Angle |
| D Back Angle° | K Between Wheels | P <input type="checkbox"/> Flexible Backpost Cap AD20310 | STYLE |
| E Seat to Foot-plate | L Foot-plate Position | Q <input type="checkbox"/> Binding Mounts
<small>(fixed back height only)</small> | W <input type="checkbox"/> 3 wheel (excluding anti-tips) |
| | | | X <input type="checkbox"/> 4 wheel |

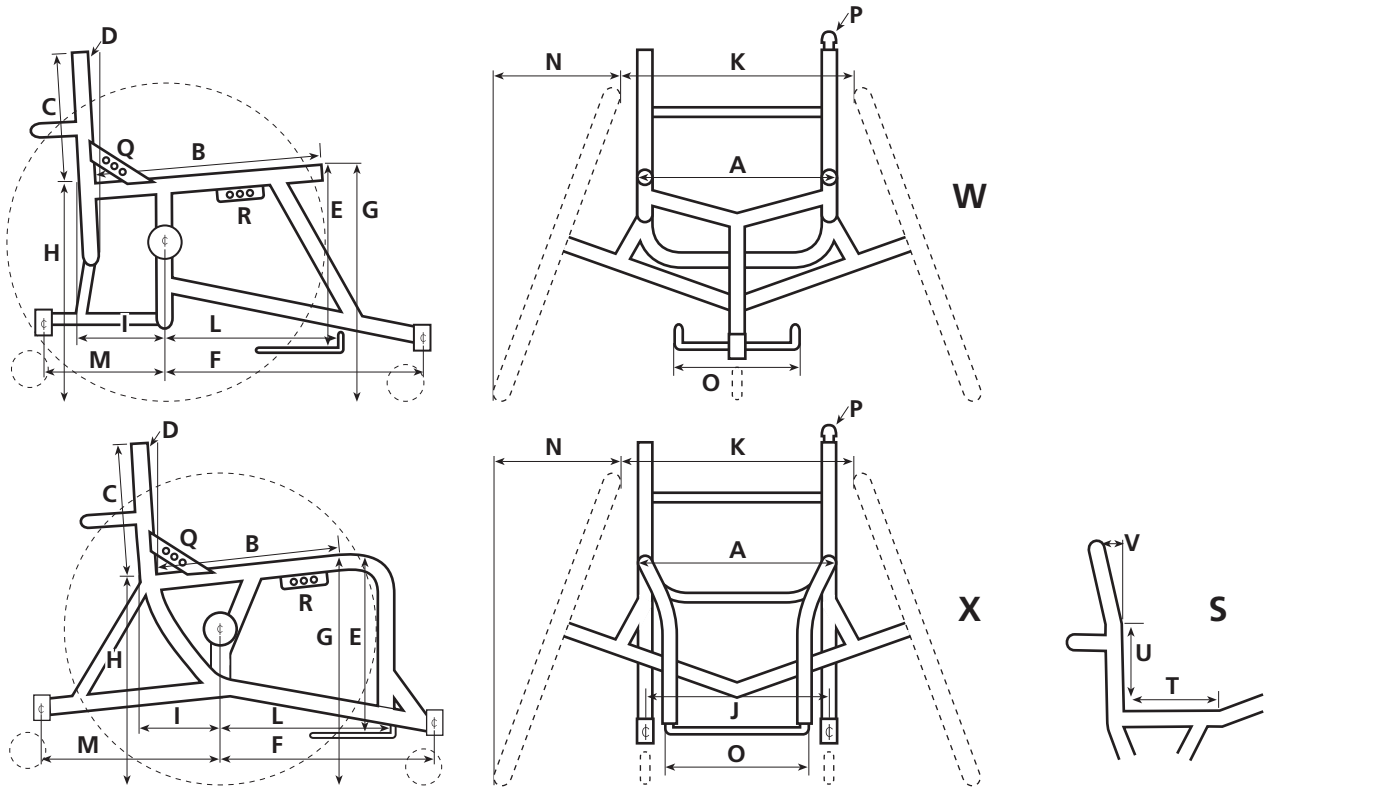

Gazelle Script Form

Tennis Sports Wheelchair

Name _____

FOOTPLATE

- No footplate Alloy tube footplate (std) Alloy footplate cover **AD11690** Angle adj footplate **AD11520**

ANTI-TIPS

- Single swivel **AD15100 (A)**
AD15102 (T) Twin swivel **AD15150 (A)**
AD15151 (T) Single swivel custom height adjustable **AD15101**

BEARINGS

- Standard bearings Melrose hybrid ceramic bearings **AD20400**

CASTORS

- Rollerblade 72mm Rollerblade 76mm Rollerblade 80mm Other _____

UPHOLSTERY

- Seat sling (std) Fixed width back (std) No cushion Cushion 3" **AD16203**
 Seat sling wrap-around Adjustable back upholstery Cushion 1" **AD16201** Cushion 1" (high density) **AD16221**
 Solid seat **AD18030** adjustable width/height **AD16050** Cushion 2" **AD16202** Cushion 2" (high density) **AD16220**

SKIRT GUARDS

- No skirt guards Fabric skirt guards **AD16100** Alloy skirt guards **AD16125 (A)**
AD16130 (T) (height) _____
(welded to alloy frame, bolted to titanium frame)
 ABS rigid skirt guards **AD16111** (height) _____

STRAPS, IMPACT GUARDS

- Front hanger covers **AD16400** Hip strap - webbing **AD16510** Knee - ratchet **AD16351**
 Back bar cover **AD16420** Hip strap - ratchet **AD16550** Leg strap **AD16330**
 Foot strap - webbing (std) Chest strap **AD45210**
(measure around your chest and seat back)
 Foot strap - ratchet **AD16350**

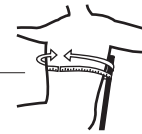
**ACCESSORIES**

- Wheel bag (black with choice of trim colour) **AD16780** (Choose your trim colour) **Bk R Bl Y Gr Pk Pu** Custom Wheel Bag **AD16781**
(describe below)

ADDITIONAL NOTES

(you can type here)

Gazelle Script Form

Tennis Sports Wheelchair

Name _____

WHEELS**24"**

- Spoked Wheels (std)
- Spinergy SL Wheels (24 spoke, black spokes only) **AD13410**
- Spinergy SLX Wheels (24 spoke, black spokes only) **AD13420**

25"

- Spoked Wheels **AD13060**
- Spinergy SL Wheels (24 spoke, black spokes only) **AD13410**
- Spinergy SLX Wheels (24 spoke, black spokes only) **AD13420**

26"

- Spoked Wheels **AD13060**
- Spinergy SL Wheels (24 spoke, black spokes only) **AD13410**
- Spinergy SLX Wheels (24 spoke, black spokes only) **AD13420**

TYRES**24"**

- 24" x 1" Kenda Ironcap Blue (std)
- 24" x 1" Kenda Konstrictor (std)
- 24" x 1" Schwalbe Right Run **AD13740**

25"

- 25" x 1" Kenda Ironcap Blue (std)
- 25" x 1" Kenda Konstrictor (std)
- 25" x 1" Kenda Kaliente **AD13721**
- 25" x 1" Schwalbe Right Run **AD13740**

26"

- 26" x 1" Kenda Ironcap Blue (std)
- 26" x 1" Schwalbe Right Run **AD13740**

PUSH-RIMS

- Anodised alloy (std) Rubber coated (red) **AD13845** Vinyl coated **AD13830**

PUSH-RIMS - POSITION

- Standard In close Onto rim

SPARE WHEELS as above

- Spoked Wheel 24" **AD13507** (quantity) _____
- Spoked Wheel 25"/26" **AD13561** (quantity) _____
- Spinergy SL Wheel **AD13641** (quantity) _____
- Spinergy SLX Wheel 1/2" axle **AD13651** (quantity) _____

TYRES, TUBES and AXLES on SPARE WHEELS

- Tube fitted **AD13695** (quantity) _____
- Kenda Tyre fitted **AD13701** (quantity) _____
- Schwalbe Tyre fitted **AD13741** (quantity) _____
- Axle 1/2" **AD12508** (quantity) _____

PUSH RIMS for SPARE WHEELS as above

- Push-Rim Anodised **AD13858** (quantity) _____
- Push-Rim Rubber Coated (Red) **AD13846** (quantity) _____
- Push-Rim Vinyl Coated **AD99999** (quantity) _____

EXTRA AXLES

- Axles 1/2" **AD12514** (quantity) _____

EXTRA BEARINGS

- Steel R8 1/2" **AD20405** (quantity) _____
- Ceramic R8 1/2" **AD20407** (quantity) _____

ADDITIONAL NOTES



















(you can type here)

Gazelle Script Form

Tennis Sports Wheelchair

Name _____

COLOURS

- 27 Candy Blue 
- 1 Royal Blue 
- 72 Glass Blue 
- 16 Candy Purple 
- 48 Burgundy 
- 83 Candy Raspberry 
- 88 Fluro Pink 
- 28 Candy Red 
- 11 Flame 
- 57 Super Hot Chilli 
- 80 Candy Orange 
- 71 Pure Orange 
- 68 Crystal Yellow 
- 73 Crystal Jade 
- 89 Fluro Green 
- 70 Candy Emerald 
- 2 Hawthorn Green 
- 17 Crystal Sapphire 

ATTENTION









THIS IS A GUIDE TO COLOURS ONLY, how colours appear on your monitor or when printed out may vary.

Contact us if you require assistance or a colour sample.

This colour selection is for our aluminum frames only.

We do not recommend powder coating titanium.

Colour availability is subject to change without notice, contact us if you are concerned about the availability of your colour.

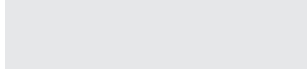
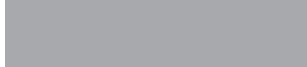
- 55 Silver Sparkle 
- 12 Silver Orbiter 
- 46 Chrome 
- 42 Metallic Viper 
- 30 Satin Black 
- 61 High Gloss Black 
- 62 Matt Black 
- 63 Texture Matt Black 
- 18 Clear 
- Bead Blast** (titanium only) 

Custom Colour (additional cost)

Description